

2436

OLDCASTLE FRP

COVER

Style:	Flush
Material:	Polymer Concrete
Model:	24" x 36"
Std. Fasteners:	1/2-13 Stainless Steel Hex Head Bolt, Washer and Floating Nut
Options:	Logos and Special Markings
Surface:	Slip Resistant
Performance:	ANSI/SCTE-77 Tier 15

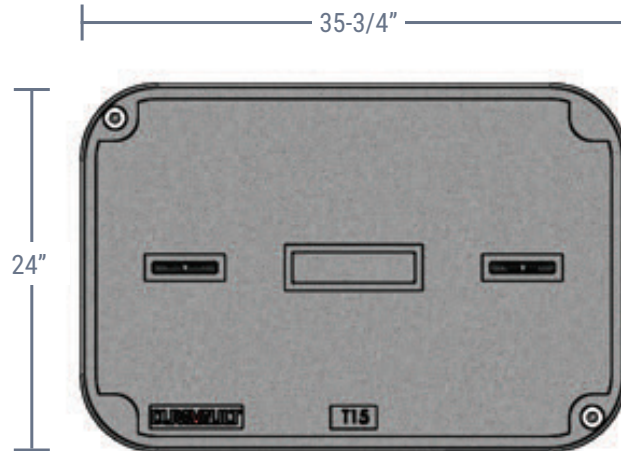

BODY

Material:	Fiber Reinforced Polymer w/ Polymer Concrete Ring
Model:	24" x 36"
Depths:	18", 24", 36", 48"
Wall Type:	Straight
Performance:	ANSI/SCTE-77 Tier 15

LOAD RATING / NOTES



MEDIUM DUTY
ANSI/SCTE TIER 15

For use in non-vehicular traffic situations only. Weights and dimensions may vary slightly. Actual load rating is determined by the box and cover combination.

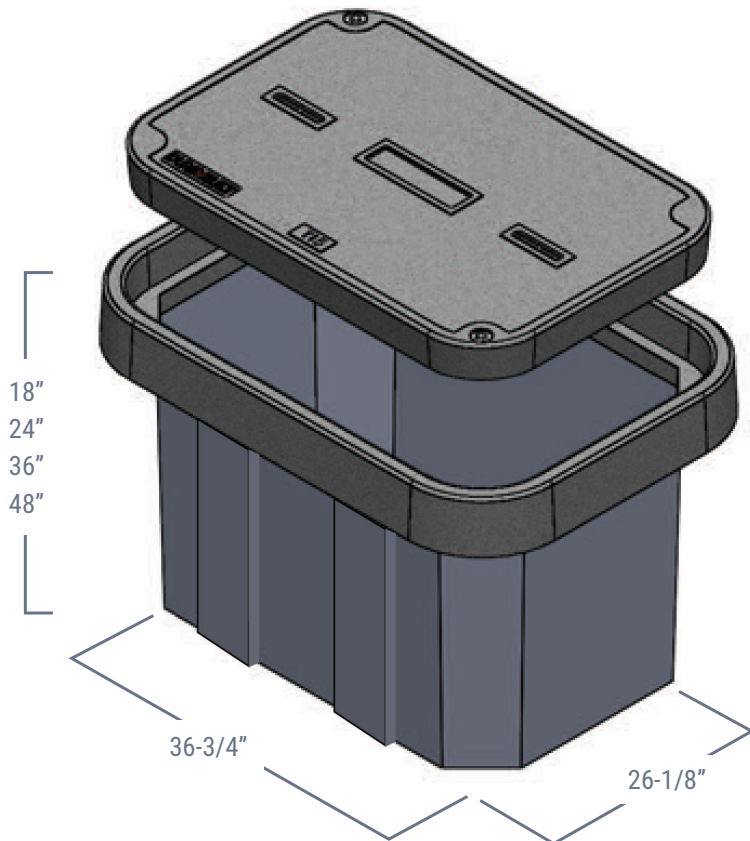

2436

OLDCASTLE FRP

COVER OPTIONS

Polymer, Flush Solid

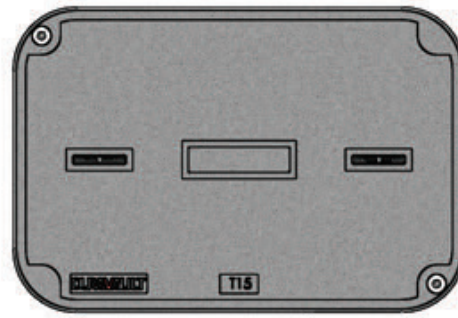

FASTENER OPTIONS

- Hex Head Bolt (A)
- Penta Head Bolt (B)
- Penta Head Coil Thread Bolt (B)
- Oldcastle Vandal Resistant Bolt (C)
- Captive Bolt Retainer



Standard Thread



A



B



C



Coil Thread



Bolt Retainer
(for standard thread)

ADD ON OPTIONS

- EMS Marker
- Mouseholes/Knockouts
- Rack Mount
- Cable Racks/Cable Arms
- Unistrut
- Pulling Eye - 1,000 lb and 3,000 lb
- Ground Buss
- Dividers
- Racking Provision
- Lid Gaskets*



Rack Mount



Cable Rack
Cable Arm



Unistrut

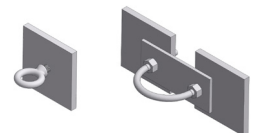

Pulling Eye



EMS Marker



Ground Buss

* Lid Gaskets inhibit water flow into the box, they do not make enclosure fully waterproof.

WARNING: Cancer - www.P65Warnings.ca.gov

All information contained on this sheet is current at the time of publication.
Oldcastle reserves the right to discontinue or update product information without notice.

Revision 11/16/18
© 2018 Oldcastle Infrastructure